

4600

Installation and User Guide



Compatible Equipment

4601	Long range and short range pendant transmitters
4602	Hand held PA
4603	Programmable transmitter
4604	Contact transmitter
4605	Short range dual channel transmitter
4608	PIR
4609	Smoke detector
7150	Viper radio vibration detector (supplied by Weyrad Electronics).

Introduction

The 4600 electronic intruder alarm system is a fully programmable, 8-zone, bells only, radio security system, designed for domestic installations and to comply with BS 6799, Class 3.

The system comprises a main control panel, which is hard-wired to an external bell/strobe, together with detector/transmitters, which are wire-free and communicate with the main control panel by means of radio signals.

Technical Specification

Electrical

Input supply voltage	= 225-253VAC, 50Hz, Max 30VA.
Short-circuit protection	= Outputs short-circuit protected for indefinite periods by means of Polyswitches which will recover after removal of short-circuit.
Reverse polarity protection	= Battery connections are reverse polarity protected for at least 5 minutes.
Battery back-up	= Back-up time, panel only with fully charged battery, typically 20 hours 12V Lead Acid battery, typically 2.1AH. Float charge voltage 13.7V typically. Charge time for flat battery, maximum 14 hours, typically 6 hours.
Auxiliary output	= 13.7VDC. Continuous current available 200mA. Maximum short term current 1A for up to 20 minutes.
Dimensions	= h x w x d 160 x 257 x 72 mm.
Weight	= 1.2 kg.
Humidity	= 80° RH.
Operating temp.	= -10° to + 55° C

Wiring

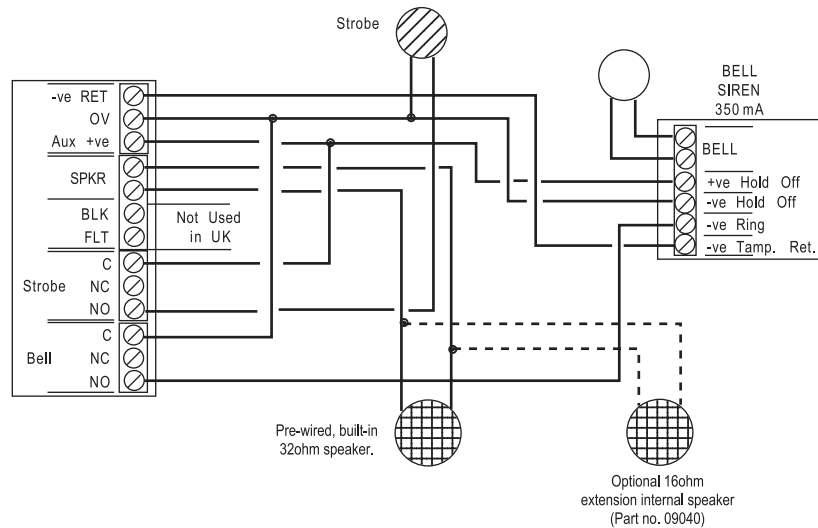

Figure 1. External SAB Bell/Strobe and Internal Speaker Connections

Notes:

1. SAB shown for negative applied. The connections shown in Figure 1 are only an example of a typical SAB module. See the bell manufacturer's instructions supplied with individual units for more information.
2. Link tamper return to 0V if no external tamper is required.
3. Connect all bell wiring to control panel with exception of the trigger to the siren or bell. The bell/siren will continue to ring from the on-board battery until the final connections are made after initial power-up.

Programming

Programming Detectors

A series of six DIL switches on the control panel main printed-circuit board enables each system to be identified by means of a different code, thereby avoiding the possibility of interference from adjacent systems. The site code is used by the control panel and all detector/transmitters in a particular system. Select a site code and set the six DIL switches. Carefully note the settings of the six site code DIL switches as this code is used when setting each transmitter/detector.

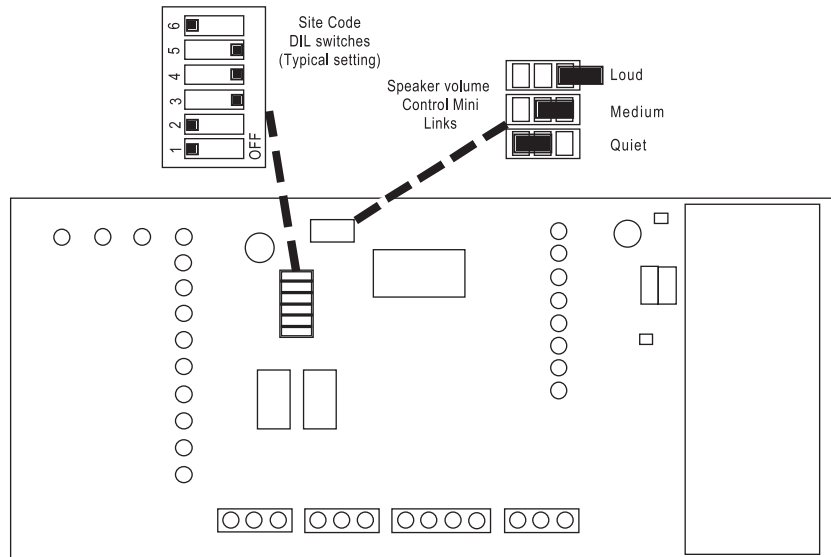

Figure 2. Setting the Site Code

Consult the sections for individual 4600 series transmitters for details on setting the DIL switches in each transmitter.

Initial Power-Up

Note: If an SAB bell is fitted to the system and completely wired, then the bell will ring until power is applied to the panel and bell lid closed.

1. Apply power.
 2. Enter the user code 1234 to silence the internal sounder.
- The panel is now in DAY mode. The walk test and other LEDs may be illuminated but please ignore them at this stage.

To Enter Programming Mode

Make sure the Day LED is glowing before trying to enter programming mode.

1. Press 0 then Enter.
2. Key in the engineer access code (default 7890).
3. Open control panel cover to activate the lid tamper switch.
All panel LEDs start to flash. You may now proceed to program the various system options with the panel open.
4. Fit programming stencil on control panel.

Programming Commands

To change the factory default program use the commands listed in this section as follows:

1. Key in the command number followed by Enter.

One of the LEDs on the display glows. The programming stencil shown in Figure 3 (Part number 495521, Issue 1) shows the LEDs used by each command.

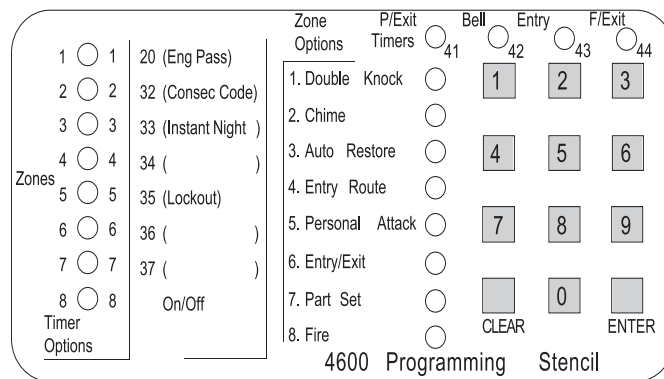

Figure 3. Programming Stencil

2. Key in the appropriate value for the command followed by Enter. See "Engineer Program Commands" for the values taken by each command.

The panel gives three short high-pitched beeps if it accepts the values you enter.

If you enter an incorrect value the panel gives a longer, lower-pitched fault tone.

When you complete a command correctly, the panel flashes all LEDs to show that it is ready for another command.

Note: It is not necessary to program all the options. Where a change has to be made to a particular option, proceed directly to the appropriate section. Refer to factory default programming.

Defaults

When delivered from the factory the panel has the following defaults:

Engineering access code 7890.

User access code is 1234.

Zone 1	Entry/Exit zone/part set/auto restore (PIR)
Zone 2	Part set/entry route zone/auto restore (PIR, VIPER)
Zone 3	Part set/entry route zone/auto restore (PIR, VIPER)
Zone 4	Auto restore (PIR, VIPER)
Zone 5	Auto restore (PIR, VIPER)
Zone 6	Nothing selected (i.e., full set only door contact)
Zone 7	PA/auto restore (Pendant or hand-held PA)
Zone 8	Fire/auto restore

All other defaults are shown in the Engineer Program Command list by a '✓'.

Engineering Program Commands

To change:	Key in:	Then:	Notes	Default
Engineer Access Code	20 ENTER	nnnn ENTER	See note 1	7890
Consecutive Code Jamming	32 ENTER	Any* ENTER	See note 2	ON
Instant Night Mode	33 ENTER	Any* ENTER	See note 3	OFF
Remote Set	34 ENTER	Any* ENTER	Zone 8 LED shows status	ON
First Zone Lockout	35 ENTER	Any* ENTER	See note 4	ON
Part Set Exit Timer	41 ENTER	1 ENTER	= 10 seconds	
		2 ENTER	= 20 seconds	✓
		3 ENTER	= 40 seconds	
		4 ENTER	= 60 seconds	
		5 ENTER	= Continuous	
		6 ENTER	= Instant (1.5s bleep followed by 20s silent)	
Bell Duration Timer	42 ENTER	1 ENTER	= 1.5 mins	
		2 ENTER	= 3 minutes	
		3 ENTER	= 5 minutes	✓
		4 ENTER	= 10 minutes	
		5 ENTER	= 15 minutes	
		6 ENTER	= 20 minutes	
		7 ENTER	= Continuous	
		8 ENTER	= 10s (for testing only)	
Entry Timer	43 ENTER	1 ENTER	= 10 seconds (see note 5)	
		2 ENTER	= 20 seconds	✓
		3 ENTER	= 40 seconds	
		4 ENTER	= 60 seconds	
Full Set Exit Timer	44 ENTER	1 ENTER	= 10 seconds	
		2 ENTER	= 20 seconds	✓
		3 ENTER	= 40 seconds	
		4 ENTER	= 60 seconds	
		5 ENTER	= Continuous	
		6 ENTER	= Final door or 60 seconds	

To change:	Key in:	Then:	Notes	Default
Zone Options (n = zone number)	5n ENTER	1	= Double knock	
		2	= Chime	
		3	= Auto Restore	
Press Clear to clear zone of any existing options.		4	= Entry Route	
		5	= Personal Attack (see note 6)	
		6	= Entry/Exit	
		7	= Part Set	
		8	= Fire	
		Press ENTER after making selections.		
Carrier Jamming Detect†	65 ENTER	Any* ENTER	Zone 8 LED shows status	ON
Bell Test	91 ENTER	Bell sounds for 10seconds (see note 7)		
Strobe Test	92 ENTER	Strobe active for 60seconds (see note 7)		
Panel sounder test	93 ENTER	Panel sounder active for 10secs (see note 7)		
Load defaults	98 ENTER			
Leave Programming	99 ENTER			

*Any = press any numbered key to toggle the option on or off. Zone 8 LED indicates the status of the current selection (LED glowing function ON).

† Not available on earlier versions of software.

Notes:

1. While entering the new password, zone 1 LED flashes.
2. Zone 2 LED glows and zone 8 LED shows the status of the Consecutive Code Checking function.
3. Zone 3 LED glows and zone 8 shows the status of the Instant Night Mode (LED glowing-Function ON). Instant Night Mode only affects entry/exit zones that are also part-set zones. If the mode is ON, part-set entry/exit zones become instant alarm zones, rather than entry/exit zones during part-set mode only. If the mode is OFF, the part-set entry/exit zones are entry/exit zones as normal. This mode has no affect in the full-set mode or on entry/exit zones that are not part-set zones.
4. Unless Entry Route zones are included, DO NOT select the First Zone Lockout function, as an entry fault would make it impossible to unset the panel without first creating an alarm condition.
5. The 4600 system features a two-ply entry time. After the selected entry time has expired, the system will enter into an internal alarm for a period equal to 50% of the selected entry time. If the panel is not unset by entering a valid code by the time the 50% extra time has expired, the system will enter into a full alarm condition (internal sounders/external bell and strobe).
6. If you do not select an option for a zone it becomes a Normal Night zone. The system will not let you select certain options together, for example: entry route and PA zone.
You must select Auto restore for PIRs, smoke detectors, Viper detectors, and PAs.
7. Press Enter to end test prematurely.

Leaving Programming Mode

When all programming is complete:

1. Remove the programming stencil and close the panel.
2. Key in 99 then Enter.

The panel returns to Day mode.

If faults are present on entering the Day mode, the panel gives a low-high bleep. Investigate any faults before proceeding. If the control panel does not go into the Day mode, either the control panel lid or bell cover is open.

Restoring Factory Defaults

1. Enter programming mode.

All LEDs flash.

2. Key in 98 then Enter.

The panel loads all the factory defaults.

Note: Using this command will erase all values, including user and engineer codes, which have been previously programmed. If you have lost the engineer or user code, you may load the factory default programme by removing all power and holding down OMIT and 1 while restoring power.

Testing

Walk Test

The system flashes the Walk Test LED after a preset number of operations to advise you to carry out a walk test.

1. Key in 3 then Enter.
2. Enter the user code (default 1234).
The Test LED glows steadily.
3. Open or activate each zone in turn.
The appropriate zone LED glows as you activate the zone. The panel gives a loud tone while the zone is open or activated. When you close the zone the display shows the next open or activated zone, or continues to display the last open or activated zone if there are no other zones open.

Note: In normal use the 4608 uses a 2.5 minute lockout time in order to extend battery life. The lockout timer works as follows:

- a) The unit detects movement, signals the panel, and starts the lockout timer.*
- b) If the unit detects movement while the lockout timer is running, then it restarts the lockout timer but does not signal the panel.*
- c) When the lockout timer expires the unit signals the panel the next time it detects movement.*

If you want to test the unit in normal use you should wait at least three minutes between activations.

On older units, enter user code (default 1234) and then key in 3. The test LED glows steadily. Carry on from step 3.

Fault Finding

Under normal operating conditions, the Fault and Alarm LEDs are dark (the power LED glows while mains is on). The Walk Test LED flashes after a preset number of operations to advise that a walk test should be carried out. Any other LEDs glowing or flashing signify either a fault or alarm condition, as follows:

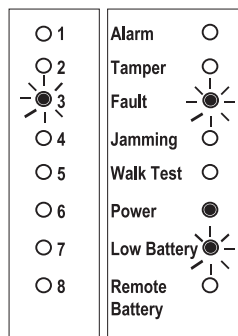

Low battery on zone detector. Replace battery.

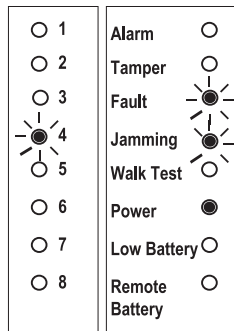

Jamming present on zone 4. Check for interfering radio signals. Activate detector/transmitter and enter user code twice. If fault persists then call Scantronic product support.

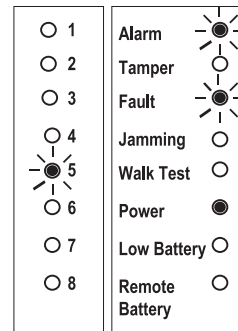

Zone activated during exit time or during re-arm period after an alarm. Enter user code twice.

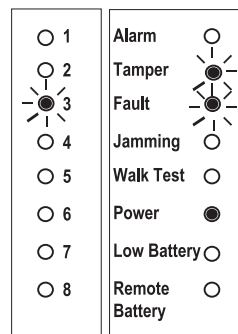

Tamper on zone active during exit time or during re-arm period after an alarm. Enter user code twice.

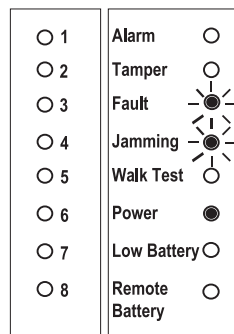

Radio frequency blocked. Call Scantronic technical support.

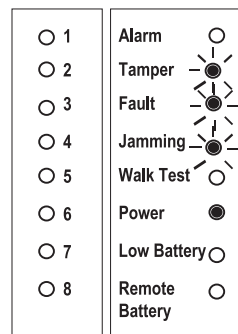

Consecutive code jamming detected. Illegal attempts made to establish system site code.

Figure 4. Fault Finding Displays

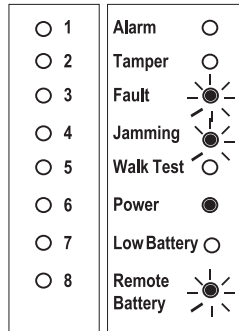

Remote setting transmitter jammed on. Check for obvious causes, e.g. test switch turned on.

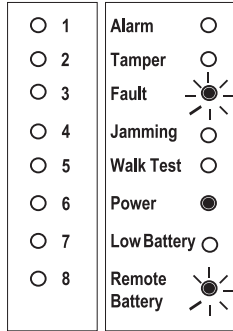

Low battery on remote setting transmitter. Replace battery.

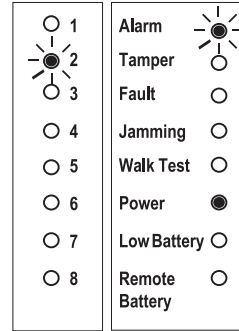

Zone indicated has been activated.

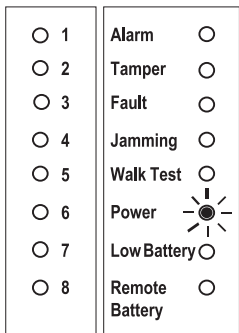

If the mains fails then the power LED flashes.

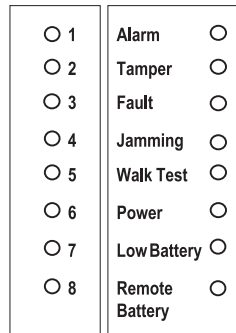

If the battery voltage is low then the power LED goes dark and the panel beeps every 30s. When the battery voltage falls below 8V (approx) then the panel stops operating.

Figure 5. Fault Finding Displays Continued

User Commands

From the Keypad

Full Set	User code + 2
Unset	User code
Part Set	User code + 1
Omit Zones	User code + 2 + OMIT + zone number. (Repeat OMIT + zone number for all zones to be omitted.)
Keypad PA	1 + 3
Silence Bells	User code
Reset	User code
Change User Code	6 + Enter + existing code + new code + Enter
Walk Test	3 + Enter + User code + activate detectors + Enter to end test On older units: User code + 3 + Enter + activate detectors + Enter to end test
Chime On/Off	4 + Enter + User code

From the 4605UK-55 Remote Setting Device

Full Set	Press top button
Unset	Press top button
PA	Press the two orange side buttons together

